

I-BOX

Kompakt, einfach und effizient

Die i-box wurde 2010 entwickelt und wird ausschließlich in Deutschland hergestellt. Sie kann mit ihrem raffinierten Befestigungssystem schnell und einfach direkt auf den Antrieb aufgebaut werden und ist dadurch äußerst platzsparend. Trotz der sehr kompakten Bauform bietet sie Platz für 1-2 mechanische Wechselschalter oder induktive Sensoren in V3-Bauform. Ihre große OPEN-CLOSED Anzeige ist auch aus großer Entfernung noch gut sichtbar. Alternativ kann sie für die Anzeige von T- oder L-Bohrungen ausgestattet werden. In der Standardausführung eignet sie sich für das Antriebsbohrbild 80x30mm mit den Wellenhöhen 20 und 30mm. Für andere Bohrbilder benötigen Sie unsere höhen- und weitenverstellbare Edelstahlbrücke IMBHV. Das i-box Gehäuse wurde durch ein externes Prüflabor auf Dichtheit geprüft und erreicht die Schutzarten IP66 und IP67 gemäß DIN EN 60529.

Compact, easy and efficient

The i-box was developed in 2010 and is exclusively produced in Germany. By means of its clever mounting system, it can be mounted quickly and directly on the actuator and is therefore extremely space-saving. Despite of the very compact design, there is place for 1-2 mechanical micro switches or inductive sensors in V3 design. Its large visual indicator OPEN-CLOSED is clearly visible from a large distance. Alternatively, it can be equipped with visual indicators for T- or L-bores. In the basic version it is suitable for the actuator hole spacing 80x30mm with shaft heights of 20 and 30mm. If you require other hole spacings, you need our stainless steel bracket IMBHV, adjustable in height and length. The i-box housing was tested in an external test laboratory and provides a degree of protection by enclosure IP66 and IP67 according to IEC 60529.



Kompakte Kunststoff-Endschalterbox für Direktaufbau

Compact plastic limit switch box for direct mounting

PA6 / PC

i-box®



Beschreibung Description

- Sehr kompakte Endschalterbox aus Polyamid PA6
- Transparenter Polycarbonat-Deckel mit integrierter, großer OPEN-CLOSED Anzeige (Optional 2D-Anzeige für L- oder T-Stellungen)
- Direktmontage ohne Montagebrücke auf Norm-Antriebe gemäß VDI/VDE 3845:
Bohrbild: 80x30mm (Optional: 130x30mm, 50x25mm - mit IMBHV Brücke)
Wellenhöhen: 20 und 30mm (Optional: 40 und 50mm - mit IMBHV Brücke)
- Neues, einfaches und zeitsparendes Befestigungssystem
- Schutzart Gehäuse IP66 + IP67 gemäß DIN EN 60529
- Kabelverschraubung M20x1,5 schwarz (für Kabel Ø 6-12mm)
- Dichtungen TPE und NBR, Schrauben Edelstahl 1.4301, Edelstahlwelle 1.4305
- Andere Gehäuse-Farben auf Anfrage
- Anwendung: Standardanwendungen ohne explosionsfähige Atmosphäre.
1-2 mechanische Endschalter
1-2 induktive Sensoren in V3-Bauform

Model: IP



**IP66/IP67
-25°C...+80°C**

- Very compact limit switch box polyamide PA6
- Transparent polycarbonate cover with integrated large OPEN-CLOSED indicator (Optional 2D indicator for L- or T-bores)
- Direct mounting without mounting bracket on actuators according to VDI/VDE 3845:
Hole spacing: 80 x 30mm (optional: 130x30mm, 50x25mm - with IMBHV bracket)
Shaft heights: 20 or 30mm (optional: 40 and 50mm - with IMBHV bracket)
- Easy and time-saving fastening system
- Enclosure IP66 + IP67 according to DIN EN 60529 (tested by external test laboratory)
- Cable gland M20x1,5 black (for cable Ø 6-12mm)
- Sealings TPE and NBR, Screws AISI 304, Stainless steel Shaft AISI 303
- Other colours of casing available on request
- Application: Standard applications without explosive atmosphere.
1-2 mechanical switches
1-2 proximity sensors in V3 design



Maßzeichnung Dimensions

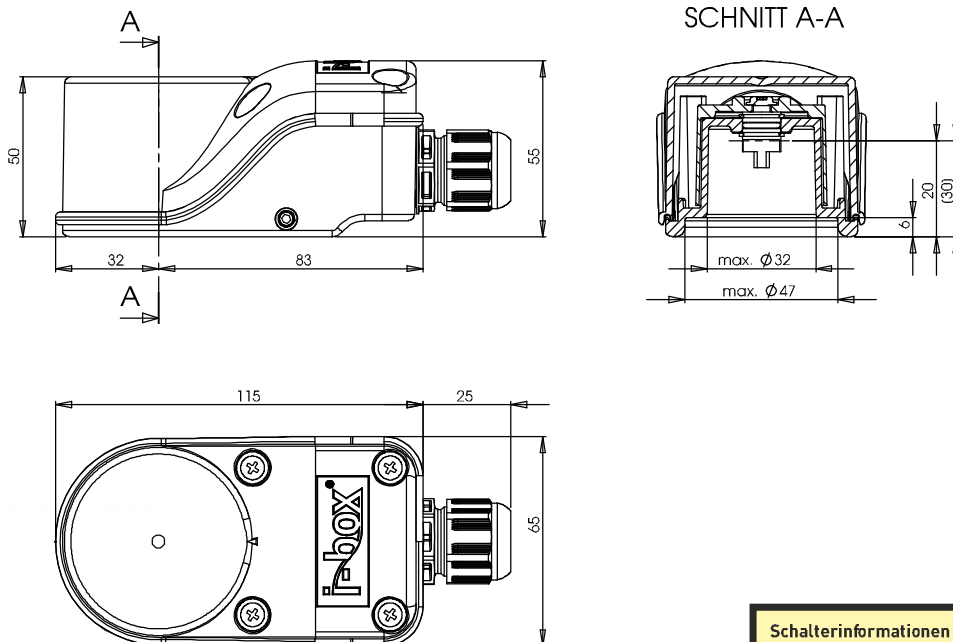

Schalterinformationen auf Seiten 03-06
Switch information on pages 03-06

Optionen Options



... Weitere Optionen auf Seite 10.
... Additional options on page 10.

i-box mit mechanischen Wechselschaltern SPDT

i-box with mechanical switches N.O./N.C. SPDT



i-box
Standard



Varianten Versions



Cherry, D44X



Cherry, D41X



Crouzet, 83161.801

Technische Daten Technical features

Endschalterfabrikat Producer switch	CHERRY	CHERRY	CROUZET
Endschaltertyp Switch type	D44X	D41X	83161.801
Spannung Voltage	24-250V	24-250V	24-250V
Maximaler Strom Maximum current	AC: 250V, 10A DC: 24V, 2,5A	AC: 250V, 0,1A DC: 24V, 0,1A	Silber: AC: 250V, 10A / DC: 24V, 2,5A Gold: AC: 250V, 0,1A / DC: 24V, 0,1A
Kontakte Contacts	Silber Silver	Gold Gold	Silber/Gold Silver/Gold
SIL Level SIL Level	SIL 1-3 (IEC 61508:2010)	SIL 1-3 (IEC 61508:2010)	SIL 1-3 (IEC 61508:2010)
Temperatur Temperature	-25°C ... +80°C	-25°C ... +80°C	-25°C ... +80°C
Zulassungen Approvals	UL auf Anfrage erhältlich UL available on request	UL auf Anfrage erhältlich UL available on request	GOST / UL
Bestellnummer Part number	IP2M01	IP2M01-G	IP2M01-488

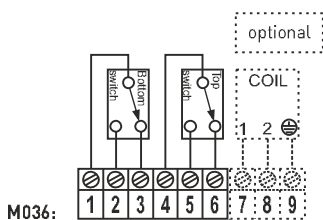

Optionen auf Seite 10
Options on page 10

Gehäuseinformationen auf Seite 02
Housing information on page 02

Artikelnummer Part number

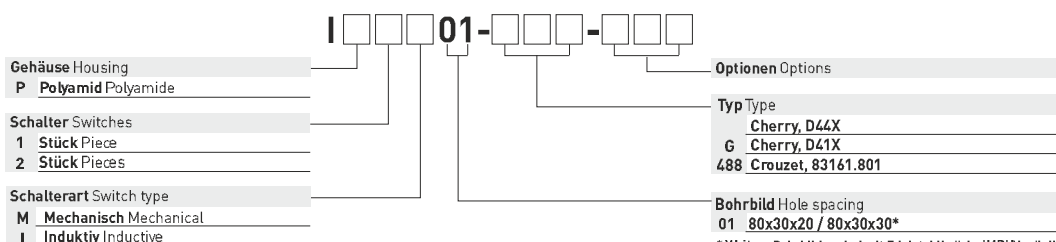

* Weitere Bohrbilder sind mit Edelstahlbrücke IMBHV möglich. Seite 187.
Other hole spacings are available with stainless steel bracket IMBHV. Page 187.

Varianten Versions



IFM, IS5001



P+F, NBB2-V3-E2



Turck, Bi2-Q10S-AP6X

Technische Daten Technical features

Endschalterfabrikat Producer switch	IFM	P+F	Turck
Endschaltertyp Switch type	IS5001 (PNP N.O.)	NBB2-V3-E2 (PNP N.O.)	Bi2-Q10S-AP6X (PNP N.O.)
Spannung Voltage	10-36V DC	10-30V DC	10-30V DC
Stromaufnahme Current consumption	0-200 mA	100 mA	15-150 mA
Schaltfrequenz Frequency	800 Hz	1000 Hz	2000 Hz
Leerlaufstrom No-load suppl. current	15 mA	15 mA	15 mA
Anzeige Output indicator	LED gelb LED yellow	LED gelb LED yellow	LED gelb LED yellow
Schutzart Schalter (IP-Code) Enclosure switch	IP67	IP67	IP67
Temperatur Temperature	-25°C ... +80°C	-25°C ... +80°C	-25°C ... +70°C
Bestellnummer Part number	IP2101-7	IP2101	IP2101-78

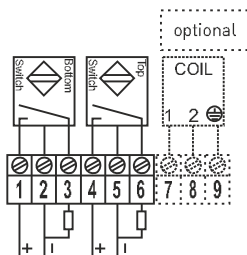

I035:

Optionen auf Seite 10
Options on page 10

Gehäuseinformationen auf Seite 02
Housing information on page 02

Artikelnummer Part number

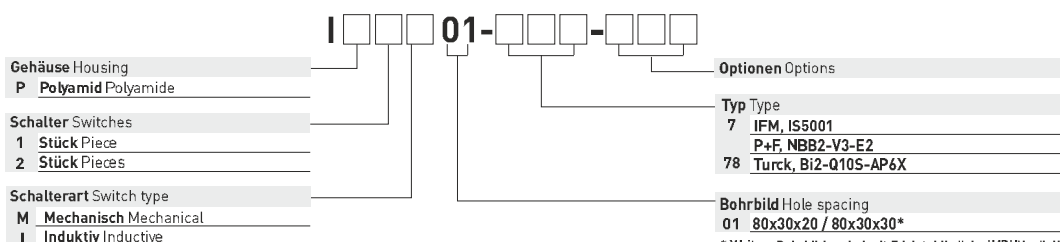

* Weitere Bohrbilder sind mit Edelstahlbrücke IMBHV möglich. Seite 187.
Other hole spacings are available with stainless steel bracket IMBHV. Page 187.

i-box mit induktiven Näherungsschaltern 2-Draht Schließer

i-box with inductive proximity switches 2-wire N.O.



i-box
Standard

Varianten Versions



IFM, IS5026



P+F, NBB3-V3-Z4



Turck, Bi2-Q10S-AZ31X

Technische Daten Technical features

Endschalterfabrikat Producer switch	IFM	P+F	Turck
Endschaltertyp Switch type	IS5026 (PNP/NPN - N.O./N.C.)	NBB3-V3-Z4 (DC N.O.)	Bi2-Q10S-AZ31X (AC/DC N.O.)
Spannung Voltage	5-36V DC	5-60V DC	10-300V DC / 20-250V AC
Stromaufnahme Current consumption	0-200 mA	4-100 mA	100 mA
Schaltfrequenz Frequency	2000 Hz	2000 Hz	50-60 Hz
Anzeige Output indicator	LED gelb LED yellow	LED gelb LED yellow	LED rot LED red
Schutzart Schalter (IP-Code) Enclosure switch	IP67	IP67	IP67
Temperatur Temperature	-25°C ... +80°C	-25°C ... +80°C	-25°C ... +70°C
Bestellnummer Part number	IP2101-19	IP2101-9	IP2101-371

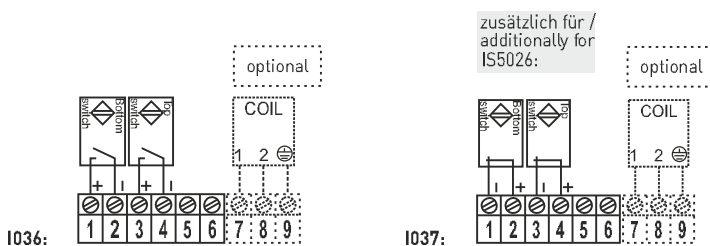

Optionen auf Seite 10
Options on page 10

Gehäuseinformationen auf Seite 02
Housing information on page 02

Artikelnummer Part number

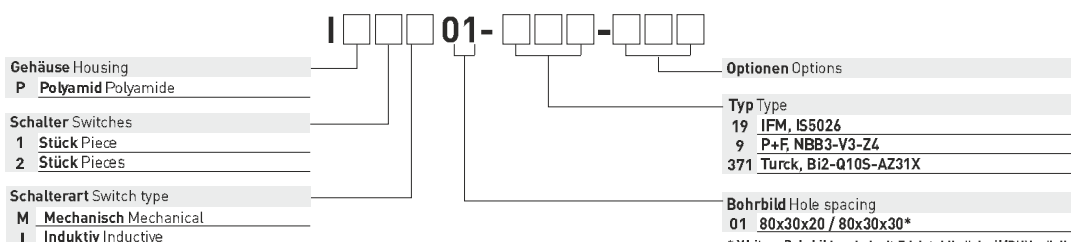

* Weitere Bohrbilder sind mit Edelstahlbrücke IMBHV möglich. Seite 187.
Other hole spacings are available with stainless steel bracket IMBHV. Page 187.

i-box mit mechanischen Wechselschaltern SPDT für AS-i Anbindung

i-box with mechanical switches N.O./N.C. SPDT for AS-i connection



Varianten Versions



Bild enthält Zubehör
Photo contains accessories

Optionen auf Seite 10
Options on page 10

Gehäuseinformationen auf Seite 02
Housing information on page 02

Cherry, D44X

Technische Daten Technical features

Endschalterfabrikat Producer switch	CHERRY
Endschaltertyp Switch type	D44X
AS-i Anbindung AS-i connection	1 AB Module Spec. 2.1 (2.0 available on request)
Spannung Voltage	30 V (18...31,6V)
Maximaler Strom Maximum current	80 mA
Kontakte Contacts	Silber Silver
SIL Level SIL Level	SIL 1-3 (IEC 61508:2010)
Temperatur Temperature	-20°C ... +70°C
Bestellnummer Part number	IP2M01-ASI-M12

Zubehör Accessories



AS-i Flachkabelklemme für die Einbindung der Box in das AS-i Netzwerk
AS-i flat cable connector for the connection of the i-box to the AS-i network

E70096



AS-i Verbindungskabel für den Anschluss von 1 Magnetspule an die i-box (nur Spulen mit 24V DC und max. 2,4W)
AS-i connection cable for the connection of 1 solenoid coil to the i-box (only coils with 24V DC and max. 2,4W)

1435195



AS-i Verbindungskabel für den Anschluss von 2 Magnetspulen an die i-box (nur Spulen mit 24V DC und max. 2,4W)
AS-i connection cable for the connection of 2 solenoid coils to the i-box (only coils with 24V DC and max. 2,4W)

1458473 + 1454516

Anschluss Connection

Data bits

Data bit	Type	Designation	Description
D2	input	Sensor 1	Sensor position 1 activated
D3	input	Sensor 2	Sensor position 2 activated
D0	output 1	Solenoid coil 1	Output for solenoid coil 1
D1	output 2	Solenoid coil 2	Output for solenoid coil 2

Connection

M12 plug	PIN	M12 socket	PIN
AS-i +	4	Solenoid coil 1 +	4
AS-i -	3	Solenoid coil 2 +	3
	2	Voltage -	2



Artikelnummer Part number

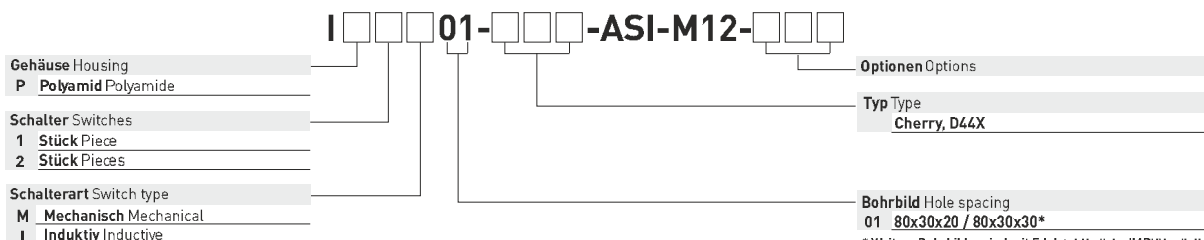

* Weitere Bohrbilder sind mit Edelstahlbrücke IMBHV möglich. Seite 187.
Other hole spacings are available with stainless steel bracket IMBHV. Page 187.

Kompakte und leitfähige Vestamid-Endschalterbox für Direktaufbau

Compact and conductive vestamide limit switch box for direct mounting

Ex ia: EPS 14 ATEX 1 641 X | IECEx EPS 14.0015X

i-box®



i-box
Ex ia

Beschreibung Description

- Sehr kompakte Endschalterbox aus leitfähigem Vestamid
- Transparenter Polycarbonat-Deckel mit integrierter, großer OPEN-CLOSED Anzeige (Optional 2D-Anzeige für L- und T-Stellungen)
- Direktmontage ohne Montagebrücke auf Norm-Antriebe gemäß VDI/VDE 3845:
Bohrbild: 80x30mm (Optional: 130x30mm, 50x25mm - mit IMBHV Brücke)
Wellenhöhen: 20 und 30mm (Optional: 40 und 50mm - mit IMBHV Brücke)
- Neues, einfaches und zeitsparendes Befestigungssystem
- Schutzart Gehäuse IP66 + IP67 gemäß DIN EN 60529
- Kabelverschraubung M20x1,5 blau (für Kabel Ø 6-12mm)
- Dichtungen TPE und NBR, Schrauben Edelstahl 1.4301, Edelstahlwelle 1.4305
- Anwendung: Explosionsgefährdete Bereiche der Zone 1 und 21 (Ex ia)
1-2 mechanische Endschalter
1-2 induktive Sensoren in V3-Bauform

Model: IV-IA



IP66/IP67
-25°C...+70°C

- Very compact limit switch box in conductive vestamide
- Transparent polycarbonate cover with integrated large OPEN-CLOSED indicator (Optional 2D indicator for L- or T-positions)
- Direct mounting without mounting bracket on actuators according to VDI/VDE 3845:
Hole spacing: 80 x 30mm (optional: 130x30mm, 50x25mm - with IMBHV bracket)
Shaft heights: 20 or 30mm (optional: 40 and 50mm - with IMBHV bracket)
- New, easy and time-saving fastening system
- Enclosure IP66 + IP67 according to DIN EN 60529
- Cable gland M20x1,5 blue (for cable Ø 6-12mm)
- Sealings TPE and NBR, Screws AISI 304, Stainless steel shaft AISI 303
- Application: Explosive atmospheres of zone 1 and 21 (Ex ia)
1-2 mechanical switches
1-2 proximity sensors in V3 design



Maßzeichnung Dimensions

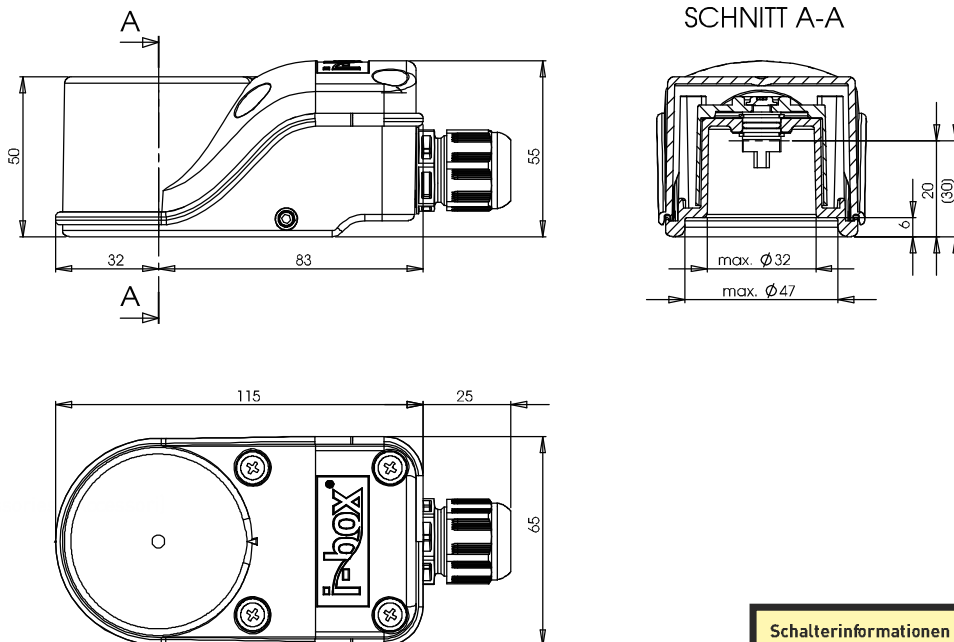

Optionen Options



... weitere Optionen auf Seite 10.
... Additional options on page 10.

i-box mit mechanischen Goldkontaktschaltern für Eigensicherheit

i-box with mechanical gold-contact switches for intrinsically safety

Ex ia: EPS 14 ATEX 1 641 X | IECEx EPS 14.0015X



Varianten Versions



Cherry, D41X



Crouzet, 83161.801

Technische Daten Technical features

Endschalterfabrikat Producer switch	CHERRY	CROUZET	
Endschaltertyp Switch type	D41X (N.O.)	83161.801 (N.O.)	
Spannung Voltage	8,2V	8,2V	
Kontakte Contacts	Gold	Gold	
SIL Level SIL Level	SIL 1-3 (IEC 61508:2010)	SIL 1-3 (IEC 61508:2010)	
Umgebungstemperatur Ambient temperature	-25°C ... +70°C	-25°C ... +70°C	
ATEX/IECEX ATEX/IECEX	⚡ II 2G Ex ia IIB T6 Gb ⚡ II 2D Ex ia IIIC T80°C Db	⚡ II 2G Ex ia IIB T6 Gb ⚡ II 2D Ex ia IIIC T80°C Db	
EG-Baumusterprüfbescheinigung CE Type examination certificate	EPS 14 ATEX 1641 X IECEX EPS 14.0015X	EPS 14 ATEX 1641 X IECEX EPS 14.0015X	
Ex-Zone Ex zone	Zone1, Zone 21	Zone1, Zone 21	
Bestellnummer Part number	IV2M01-G-IA	IV2M01-488-IA	

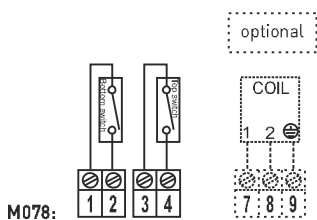

Optionen auf Seite 10
Options on page 10

Gehäuseinformationen auf Seite 07
Housing information on page 07

Artikelnummer Part number

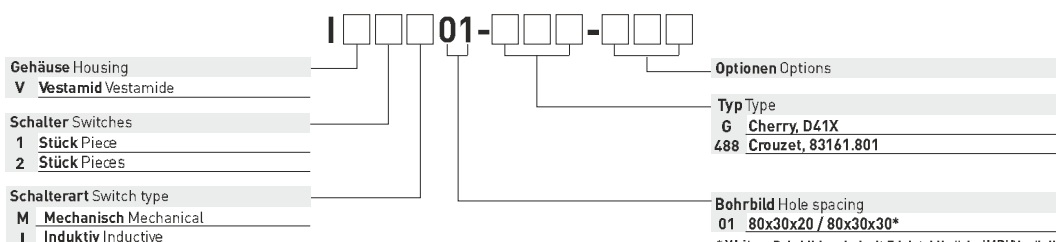

* Weitere Bohrbilder sind mit Edelstahlbrücke IMBHV möglich. Seite 187.
Other hole spacings are available with stainless steel bracket IMBHV. Page 187.

i-box mit eigensicheren, induktiven Näherungsschaltern

i-box with intrinsically safe, inductive proximity switches

Ex ia: EPS 14 ATEX 1 641 X | IECEx EPS 14.0015X



Varianten Versions



IFM, NS5002



P+F, NJ2-V3-N



Turck, Bi2-Q10S-X1X

Technische Daten Technical features

Endschalterfabrikat Producer switch	IFM	P+F	Turck
Endschaltertyp Switch type	NS5002 (Öffner N.C.)	NJ2-V3-N (Öffner N.C.)	Bi2-Q10S-Y1X (Öffner N.C.)
Spannung Voltage	8,2V DC	8,2V DC	8,2V DC
Stromaufnahme Current consumption	≤ 1,0 mA ≥ 2,1 mA	≤ 1 mA ≥ 3 mA	≤ 1,2 mA ≥ 2,1 mA
Schaltfrequenz Frequency	800 Hz	1000 Hz	1000 Hz
SIL Level SIL level	--	SIL 1-3 (IEC 61508:2010)	SIL 1-3 (IEC 61508:2010)
Anzeige Output indicator	-20°C ... +70°C	-25°C ... +70°C	-25°C ... +70°C
ATEX/IECEX ATEX/IECEX	II 2G Ex ia IIB T6 Gb II 2D Ex ia IIIC T80°C Db	II 2G Ex ia IIB T6 Gb II 2D Ex ia IIIC T80°C Db	II 2G Ex ia IIB T6 Gb II 2D Ex ia IIIC T80°C Db
EG-Baumusterprüfbescheinigung CE-Type examination certificate	EPS 14 ATEX 1641 X IECEX EPS 14.0015X	EPS 14 ATEX 1641 X IECEX EPS 14.0015X	EPS 14 ATEX 1641 X IECEX EPS 14.0015X
Temperatur Temperature	Zone 1, Zone 21	Zone 1, Zone 21	Zone 1, Zone 21
Bestellnummer Part number	IV2101-14-IA	IV2101-IA	IV2101-130-IA

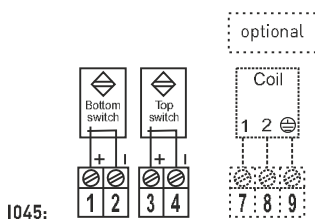

I045:

Optionen auf Seite 10
Options on page 10

Gehäuseinformationen auf Seite 07
Housing information on page 07

Artikelnummer Part number

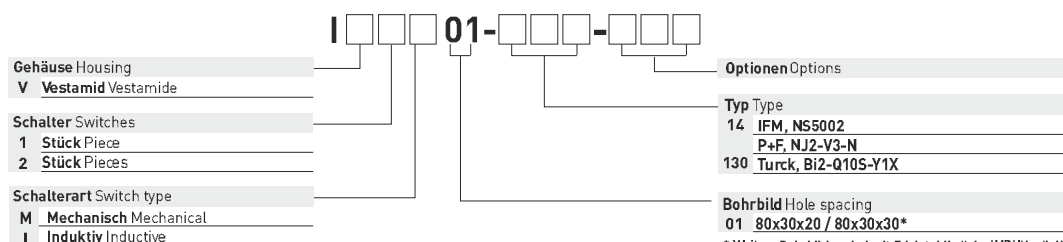

* Weitere Bohrbilder sind mit Edelstahlbrücke IMBHV möglich. Seite 187.
Other hole spacings are available with stainless steel bracket IMBHV. Page 187.

Optische Anzeigen Visual indicators



Große 3D-Anzeige im Gehäuse mit OPEN-CLOSED Beschriftung für 90° Schwenkbereich
Large 3D indicator inside the housing with OPEN-CLOSED indication for 90° swivel range

Standard



2D-Anzeige im Gehäuse zur Anzeige aller Schwenkbereiche auch außerhalb 0-90°
2D visual indicator inside the housing to indicate every swivel range also besides 0-90°

...-2D



180° Anzeigen-Skala
180° scale

...-180°



2DT-Anzeige im Gehäuse zur Visualisierung der Stellung von 3-wege Kugelhähnen (T / L)
2DT visual indicator inside the housing to indicate positions of 3 way ball valves (T / L)

...-2DT
...-2DL



LED-Anzeige im Gehäuse, orange-grün, max. 24V DC
LED indicator inside the housing, orange-green, max. 24V DC

...-LED

Anschlüsse Connections



Magnetventilanschluss für 1 Spule über vorkonfektioniertes Kabel mit 500mm Länge
Solenoid valve connection for 1 coil with pre-assembled cable of 500mm length

...-MA



Magnetventilanschluss für 2 Spulen über vorkonfionierte Kabel mit 500mm Länge
Solenoid valve connection for 2 coils with pre-assembled cables of 500mm length

...-2MA



M12-Steckverbindung 5-polig, weiblich, für schnelles und einfaches Anschließen eines Magnetventils
M12 plug connector 5 polar, female, for quick and simple connection of a solenoid valve

...-MA12



M12-Steckverbindung 5-polig, männlich, für schnelles und einfaches Anschließen
M12 plug connector 5 polar, male, for quick and easy connection

...-M12



Anklemmmöglichkeit für eine Magnetspule durch zweite Kabelverschraubung M16x1,5
Possibility to connect one solenoid coil through a second cable gland M16x1,5

...-MA3



Gewindeanschluss NPT 1/2
Thread connection NPT 1/2

...-NPT1/2

Außenaufstellung Outdoor use



Druckausgleichselement zur Vermeidung von Kondenswasserbildung im Boxengehäuse
Venting screw for the avoidance of condensation water inside of the switch box housing

...-DAE

Gehäusefarbe Housing colour



Gehäusefarbe passend zum Antrieb
Housing colour matching the actuator

...-020 = Königsblau / Royal blue
...-057 = Marineblau / Navy blue
...-010 = Grau / Grey
...-026 = Weiß / White
...-114 = Rot / Red